

Varenummer: 03554050

Beskrivelse: Fluro hydraulik ledhoved FMA 50D

## Mål

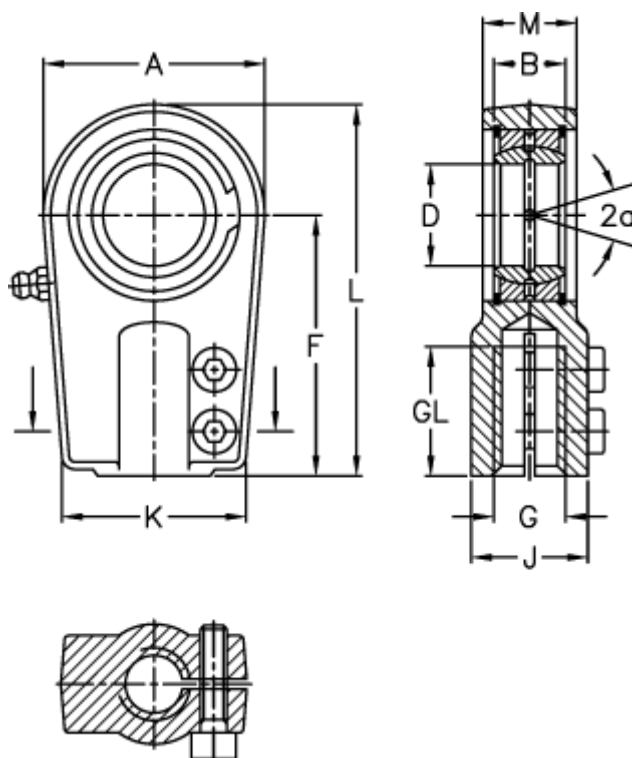

A	= 116	J	= 70
a (grader)	= 7	K	= 90
B	= 35	L	= 198
D	= 50	M	= 40
Dynamisk belastning C (kN)	= 220	Moment (Nm)	= 80
F	= 135	Statisk belastning C0 (kN)	= 442
g	= M50x3	Vægt	= 4100
GL	= 75		